

CUBE SURFACE

D72000- -

base number Color Finish
 Temperature Options

1. To build a product code in our configurator select the specify button on the base model # product page
2. To build a manual product code on this datasheet choose from the options listed below in blue font and add the suffix to the base model #

GENERAL

Series: Cube
Brand: Tunto
Division: Design
Mounting Type: Surface
Mounting Location: Wall / Ceiling
Subcategory: Ambient

PHYSICAL

Shape: Rectangle
Length (mm): 220
Length (in): 8 ¹¹/₁₆
Height (mm): 165
Depth (mm): 125
Height (in): 6 ¹/₂
Depth (in): 4 ¹⁵/₁₆
Light Distribution: Direct
Diffuser: Opal
Fixture Finish: BIR / OAK / WAL
Fixture Material: Wood

ELECTRICAL

Lamp Type: LED (Zhaga Standard)
Input Wattage (W): 11
Dimming: Tri-Mode (Non-Dimming and Phase Dimming (120Vac only) and 0-10V Dimming)
Driver Included: Yes
Driver Location: Integrated
Driver Type: Constant Current - Universal
Driver Class: Class 2
Input Voltage (V): 120 - 277
Constant Current (MA): 700

LED

Color Temperature (°K): 2700 / 3000 / 4000
Nominal Lumen (lm): 440
CRI: >93 CRI
Lamp Life (hrs): 50000

OPTICAL

RATINGS AND CERTIFICATIONS

Certified By: Certified for North American Standards
IP rating: IP20

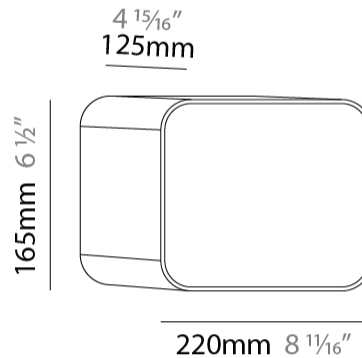

CUBE SURFACE

D72000-

PROJECT

TYPE

SPECIFIER

QUANTITY

DATE



| |
|-----------|
| PROJECT |
| TYPE |
| SPECIFIER |
| QUANTITY |
| DATE |

CUBE SURFACE

D72001- -
 base number Color Finish
 Temperature Options

- To build a product code in our configurator select the specify button on the base model # product page
- To build a manual product code on this datasheet choose from the options listed below in blue font and add the suffix to the base model #

GENERAL

Series: Cube
 Brand: Tunto
 Division: Design
 Mounting Type: Surface
 Mounting Location: Wall / Ceiling
 Subcategory: Ambient

PHYSICAL

Shape: Rectangle
 Length (mm): 250
 Length (in): 9 ¹³/₁₆
 Height (mm): 165
 Depth (mm): 220
 Height (in): 6 ¹/₂
 Depth (in): 8 ¹¹/₁₆
 Light Distribution: Direct
 Diffuser: Opal
 Fixture Finish: BIR / OAK / WAL
 Fixture Material: Wood

ELECTRICAL

Lamp Type: LED
 Input Wattage (W): 16
 Dimming: Tri-Mode (Non-Dimming and Phase Dimming (120Vac only) and 0-10V Dimming)
 Driver Included: Yes
 Driver Location: Integrated
 Driver Type: Constant Current - Universal
 Driver Class: Class 2
 Input Voltage (V): 120 - 277
 Constant Current (MA): 700

LED

Color Temperature (°K): 2700 / 3000 / 4000
 Nominal Lumen (lm): 440
 CRI: >93 CRI
 Lamp Life (hrs): 50000

OPTICAL

RATINGS AND CERTIFICATIONS

Certified By: Certified for North American Standards
 IP rating: IP20



CUBE SURFACE

D72001-

PROJECT

TYPE

SPECIFIER

QUANTITY

DATE



PROJECT _____
 TYPE _____
 SPECIFIER _____
 QUANTITY _____
 DATE _____

CUBE SURFACE

D72002- _____ - _____
 base number Color Finish
 Temperature Options

- To build a product code in our configurator select the specify button on the base model # product page
- To build a manual product code on this datasheet choose from the options listed below in blue font and add the suffix to the base model #

GENERAL

Series: Cube
 Brand: Tunto
 Division: Design
 Mounting Type: Surface
 Mounting Location: Wall / Ceiling
 Subcategory: Ambient

PHYSICAL

Shape: Rectangle
 Length (mm): 280
 Length (in): 11
 Height (mm): 165
 Depth (mm): 250
 Height (in): 6 1/2
 Depth (in): 9 13/16
 Light Distribution: Direct
 Diffuser: Opal
 Fixture Finish: BIR / OAK / WAL
 Fixture Material: Wood

ELECTRICAL

Lamp Type: LED
 Input Wattage (W): 20
 Dimming: Tri-Mode (Non-Dimming and Phase Dimming (120Vac only) and 0-10V Dimming)
 Driver Included: Yes
 Driver Location: Integrated
 Driver Type: Constant Current - Universal
 Driver Class: Class 2
 Input Voltage (V): 120 - 277
 Constant Current (MA): 700

LED

Color Temperature (°K): 2700 / 3000 / 4000
 Nominal Lumen (lm): 1000
 CRI: >93 CRI
 Lamp Life (hrs): 50000

OPTICAL

RATINGS AND CERTIFICATIONS

Certified By: Certified for North American Standards
 IP rating: IP20



CUBE SURFACE

D72002-

PROJECT

TYPE

SPECIFIER

QUANTITY

DATE

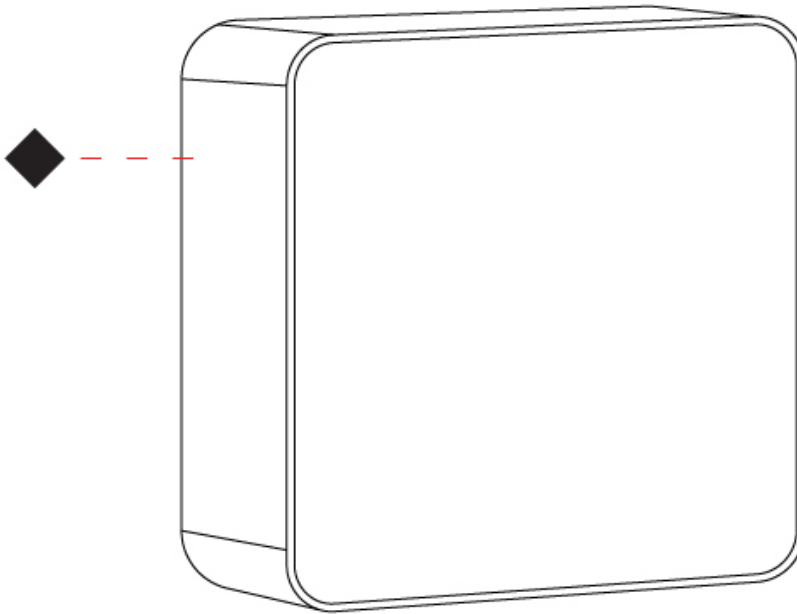

PROJECT _____
 TYPE _____
 SPECIFIER _____
 QUANTITY _____
 DATE _____

CUBE SURFACE

D72003- _____ - _____
 base number Color Finish
 Temperature Options

- To build a product code in our configurator select the specify button on the base model # product page
- To build a manual product code on this datasheet choose from the options listed below in blue font and add the suffix to the base model #

GENERAL

Series: Cube
 Brand: Tunto
 Division: Design
 Mounting Type: Surface
 Mounting Location: Wall / Ceiling
 Subcategory: Ambient

PHYSICAL

Shape: Rectangle
 Length (mm): 500
 Length (in): 19 ¹¹/₁₆"
 Height (mm): 280
 Depth (mm): 85
 Height (in): 11
 Depth (in): 3 ³/₈"
 Light Distribution: Direct
 Diffuser: Opal
 Fixture Finish: BIR / OAK / WAL
 Fixture Material: Wood

ELECTRICAL

Lamp Type: LED
 Input Wattage (W): 28
 Dimming: Tri-Mode (Non-Dimming and Phase Dimming (120Vac only) and 0-10V Dimming)
 Driver Included: Yes
 Driver Location: Integrated
 Driver Type: Constant Current - Universal
 Driver Class: Class 2
 Input Voltage (V): 120 - 277
 Constant Current (MA): 700

LED

Color Temperature (°K): 2700 / 3000 / 4000
 Nominal Lumen (lm): 1300
 CRI: >93 CRI
 Lamp Life (hrs): 50000

OPTICAL

RATINGS AND CERTIFICATIONS

Certified By: Certified for North American Standards
 IP rating: IP20



CUBE SURFACE

D72003-

PROJECT _____

TYPE _____

SPECIFIER _____

QUANTITY _____

DATE _____



| |
|-----------|
| PROJECT |
| TYPE |
| SPECIFIER |
| QUANTITY |
| DATE |

CUBE SURFACE

D72029- -
 base number Color Finish
 Temperature Options

- To build a product code in our configurator select the specify button on the base model # product page
- To build a manual product code on this datasheet choose from the options listed below in blue font and add the suffix to the base model #

GENERAL

Series: Cube
 Brand: Tunto
 Division: Design
 Mounting Type: Surface
 Mounting Location: Wall / Ceiling
 Subcategory: Ambient

PHYSICAL

Shape: Rectangle
 Length (mm): 500
 Length (in): 19 11/16
 Height (mm): 500
 Depth (mm): 85
 Height (in): 19 11/16
 Depth (in): 3 3/8
 Light Distribution: Direct
 Diffuser: Opal
 Fixture Finish: BIR / OAK / WAL
 Fixture Material: Wood

ELECTRICAL

Lamp Type: LED
 Input Wattage (W): 37
 Dimming: Tri-Mode (Non-Dimming and Phase Dimming (120Vac only) and 0-10V Dimming)
 Driver Included: Yes
 Driver Location: Integrated
 Driver Type: Constant Current - Universal
 Driver Class: Class 2
 Input Voltage (V): 120 - 277
 Constant Current (MA): 700

LED

Color Temperature (°K): 2700 / 3000 / 4000
 Nominal Lumen (lm): 1800
 CRI: >93 CRI
 Lamp Life (hrs): 50000

OPTICAL

RATINGS AND CERTIFICATIONS

Certified By: Certified for North American Standards
 IP rating: IP20



CUBE SURFACE

D72029-

PROJECT _____

TYPE _____

SPECIFIER _____

QUANTITY _____

DATE _____



CUBE COLOR FINISH CHART

| | |
|-----------|-------|
| PROJECT | _____ |
| TYPE | _____ |
| SPECIFIER | _____ |
| QUANTITY | _____ |
| DATE | _____ |

Fixture Finish

Birch - BIR



Oak Natural - OAK



Walnut Natural - WAL



Digital: Not all screens are calibrated the same, and therefore, colors will appear differently between screens.

Physical: When texture is involved, there will be variations in color, character and tone within a product series and between product families.

Wood is a living, organic material. Hence, the patterns and hues can vary, and can change as the material ages. We are not responsible for any natural material transformation and development.













| | |
|-----------|--|
| PROJECT | |
| TYPE | |
| SPECIFIER | |
| QUANTITY | |
| DATE | |











LEGEND

| | | |
|--|--|--|
|  floor-mounted |  pivotable |  special LED (upon request) RGB, RGBW, tunable, gold+, meat+, art+, fashion+ |
|  wall and ceiling: recessed and surface mounted |  rotating |  warm dim / natural dimming LED |
|  ceiling-mounted and wall-mounted |  illuminate tilted |  rechargeable battery powered |
|  wall-mounted |  color of suspension cable |  fixture with natural vivid LED (upon request) |
|  omni-directional light distribution |  length of suspension cable |  color rendering index |
|  direct light distribution |  reflector degree selection |  color temperature |
|  direct/indirect light distribution |  super spot |  lumen (luminous flux) |
|  indirect light distribution |  lens |  efficacy (lumens per watt) |
|  asymmetric light distribution |  lens pack |  Unified Glare Rating (UGR) range from 5-40 |
|  aura light distribution |  shine ring |  marine grade (AISI 316 stainless steel) |
|  round wall or ceiling cut-out |  integrated shine ring with diffuser |  walk on |
|  square wall or ceiling cut-out |  free individual colors 01-29 |  drive on |
|  the supplied jig specifies the cutout dimensions |  individual colors: 00 (free of charge), 01-25 (extra charge) |  Dark Sky Compliance |
|  minimum distance (meters) lamp - object |  luminaire part to be colored (F1) |  Americans with Disabilities Act (less than 4" off the wall located between 27"-84" from floor) |
|  recessed depth |  luminaire part to be colored (F2) |  lamp protected against explosion |
|  ceiling thickness in mm |  luminaire part to be colored (F3) |  blown glass using traditional methods by master glass blower |
|  ceiling thickness selection |  luminaire part to be colored (F4) |  acoustic material |
|  dimmable DP (phase), DV (0-10V), DD (dali), DS (step-dim) |  luminaire part to be colored (F5) |  protection class I, protection insulation |
|  included or excluded LED driver/transformer/control gear |  color of 3-circuit adaptor |  protection class II, protection insulation |
|  separately switchable |  indirect diffuser |  ETL Certified to UL and CSA Standards |
|  sensor |  direct diffuser |  UL Certified to UL and CSA Standards |
|  remote control |  ball-proof (upon request) |  CSA Certified to UL and CSA Standards |
|  available upon request |  accessory |  Certified for North American Standards |

IP RATING

| | |
|--|--|
|  IP20 | protected against ingress of solid bodies greater than 12.5mm (finger) |
|  IP33 | protected against ingress of solid bodies greater than 2.5mm protected against sprays of water up to 60 degrees from the vertical (rain) |
|  IP40 | protected against ingress of solid bodies greater than 1mm (wire) no protection against the ingress of moisture |
|  IP43 | protected against ingress of solid bodies greater than 1mm (wire) protected against sprays of water up to 60 degrees from the vertical (rain) |
|  IP44 | protected against ingress of solid bodies greater than 1mm (wire) protected against water splashed from all directions |
|  IP54 | protected against limited ingress of dust (wet rooms/covered outdoor areas) protected against water splashed from all directions |
|  IP65 | protected against ingress of dust protected against jets of water |
|  IP66 | protected against ingress of dust protected against powerful jets of water or heavy seas |
|  IP67 | protected against ingress of dust protected against immersion of water between 15cm - 1m for 30 minutes |
|  IP68 | protected against ingress of dust protected against immersion of water under pressure for long periods |

IK RATING

| | |
|--|---|
|  IK01 | protected against 0.14 joules impact (equivalent to 0.25kg mass dropped from 56mm above the surface) |
|  IK02 | protected against 0.2 joules impact (equivalent to 0.25kg mass dropped from 80mm above the surface) |
|  IK03 | protected against 0.35 joules impact (equivalent to 0.25kg mass dropped from 140mm above the surface) |
|  IK04 | protected against 0.5 joules impact (equivalent to 0.25kg mass dropped from 200mm above the surface) |
|  IK05 | protected against 0.7 joules impact (equivalent to 0.25kg mass dropped from 280mm above the surface) |
|  IK06 | protected against 1 joules impact (equivalent to 0.25kg mass dropped from 400mm above the surface) |
|  IK07 | protected against 2 joules impact (equivalent to 0.5kg mass dropped from 400mm above the surface) |
|  IK08 | protected against 5 joules impact (equivalent to 1.7kg mass dropped from 300mm above the surface) |
|  IK09 | protected against 10 joules impact (equivalent to 5.0kg mass dropped from 200mm above the surface) |
|  IK10 | protected against 20 joules impact (equivalent to 5.0kg mass dropped from 400mm above the surface) |